

ASP®

Specialty High Alloys

F321 - AL6XN - F317/317L DUPLEX

MONEL 400 - HASTEALLOY C-276

IN STOCK!

Visit our Website at www.alloystainless.com

**CORROSION RESISTANT
PIPE FITTINGS**

STAINLESS STEEL



**ALLOY STAINLESS
PRODUCTS COMPANY INC.**
611 UNION BLVD., TOTOWA, N.J. 07512-U.S.A.

TEL: 800-631-8372
N.J.: 973-256-1616

FAX: 800-432-9277
N.J.: 973-256-5256



Quality is more than adhering to material and dimensional specifications.

In its broadest meaning quality is a discipline that joins individual efforts into a common process toward constant improvement in all that we do.

THE ASP "Q" TEAM AIMS FOR
QUALITY PAR EXCELLENCE.

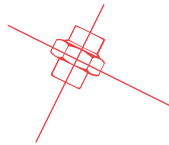



It's a long way from the Spring of '43, the year we made our debut.

We're not boasting that seventy years made us good. Age has nothing to do with it. We're good because year after year we have always done our best to make our product and our service better than before.

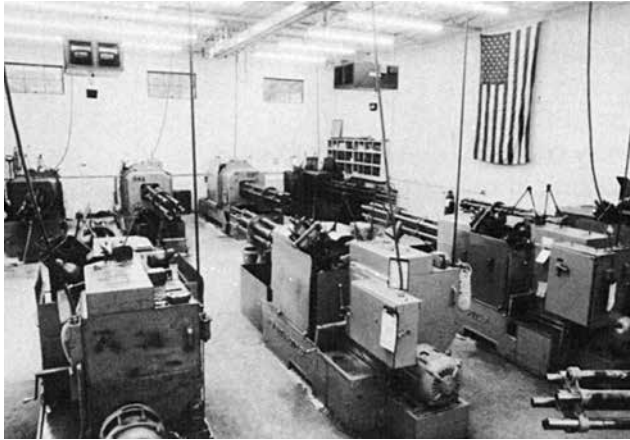

We share a special pride that to this point in time we have remained an independently owned and operated enterprise. Customers know that when they deal with ASP they can easily reach the top level every time for any decision of the moment.



Today, quality controlled materials and computerized production methods absolutely assure customer and user satisfaction. The ASP brand on every product is your guarantee that it is manufactured from material supplied from periodically audited sources and in full compliance to documented inspection procedures.

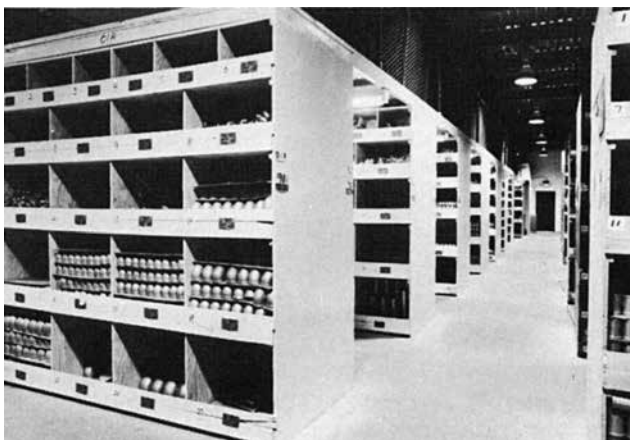

In addition to quality control, ASP is committed to an ongoing quality process involving every member of our staff from the bottom to the top level. The ASP "Q" Team, as we refer to it, strives to achieve Quality Par Excellence.

Customers and users are always welcomed to see our facility in full operation.

GENERAL INFORMATION

ASP 150 LB. STAINLESS STEEL PIPE FITTINGS

Dimensions and materials conform to MSS-SP-114, Class 150 or Class 1000, Threaded or Socket-Welding. Pipe Threads conform to ASME B1.20.1. Cast 150 LB Pipe Fittings are manufactured from material conforming to ASTM-A-351 (CF8/304, CF8M/316, or CN7M/A-20). ASP Cast 150 LB Fittings are suitable for use at pressure temperature ratings for MSS-SP-114 Class 150 Fittings (300 psi CWP / 150 psi SWP). ASP Forged/Barstock 150 LB Fittings are manufactured from forged or wrought barstock materials conforming to the chemistry of ASTM-A-182 (F304 or F316) or ASTM-B-473 (A-20) in a proper state of heat treatment to provide desired mechanical properties and corrosion resistance. ASP Forged/Barstock 150 LB Fittings are suitable for use at pressure temperature ratings for MSS-SP-114 Class 1000 Fittings (1000 psi CWP). All ASP 150 LB Stainless Steel Pipe Fittings are identified with the ASP Trademark, Nominal Pipe Size, and Material Grade.

ASP 2000 LB, 3000 LB & 6000 LB STAINLESS STEEL THREADED AND SOCKET-WELDING FITTINGS

Dimensions and materials conform to ASME B16.11, MSS-SP-79 (Inserts), MSS-SP-83 (Unions), and other standards where applicable. Threads conform to ASME B1.20.1. Socket-welding Fittings may be bored for use with Schedule 40, 80, 160, and XXS Pipe as required. Material conforms to ASTM-A-182, F304, F304L, F316, or F316L; Alloy-20 material conforms to ASTM-B-462 (forged) or ASTM-B-473 (barstock). Material conformance to QQ-S-763 and other alloys may be available upon request for quotation. All ASP 2000 LB, 3000 LB, and 6000 LB Fittings are permanently identified with the ASP Trademark, Nominal Pipe Size, Pressure Rating, Material Designation and Alloy, and Heat Code Identification.

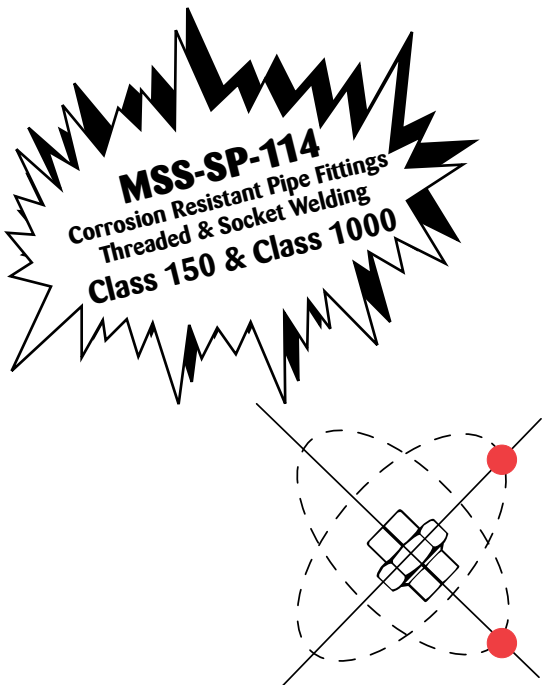

All ASP Pipe Fittings are manufactured under our Quality System Program which has been developed to meet the requirements of ISO-9001. Upon request for quotation, our Quality System Program has provisions for implementation to meet the requirements of ASME NCA-3800, NQA-1, 10CFR50 Appendix B, MIL-I-45208, MIL-STD-45662, and other quality program requirements. Additional information on Canadian Commercial Registration Numbers for both commercial and nuclear applications is available on request.

DIMENSIONS SHOWN IN THIS CATALOG ARE NOMINAL AND SUBJECT TO APPLICABLE STANDARD AND MANUFACTURER'S TOLERANCES. MATERIALS AND DIMENSIONS OTHER THAN THOSE REQUIRED BY APPLICABLE STANDARDS REFERENCED ARE SUBJECT TO CHANGE WITHOUT NOTICE AT THE MANUFACTURER'S OPTION.

ELBOWS-TEES-CROSSES

THREADED FITTINGS



FORGED

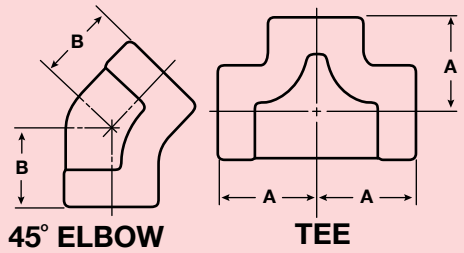
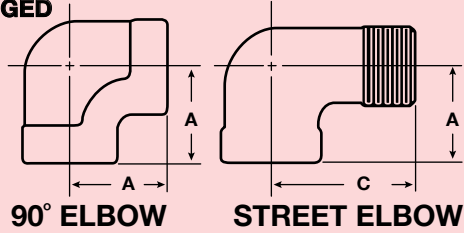

CAST

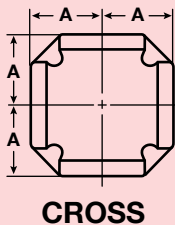
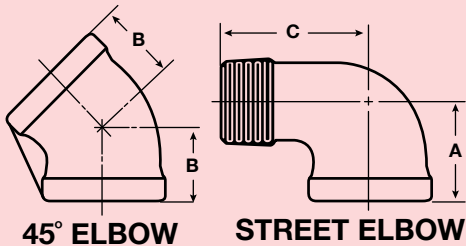
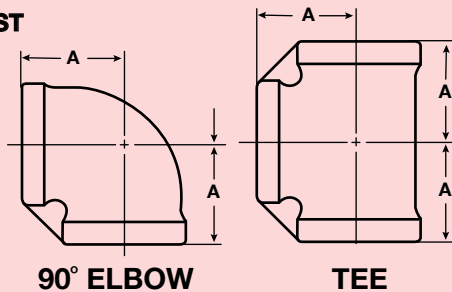

NOTES:

1. Dimensions conform to MSS-SP-114.
2. Pipe Threads conform to ASME B1.20.1.
3. Forged 150 LB Fittings are suitable for use at 1000 psi CWP.
4. Reducing 90 Degree Elbows and Tees are available on request.
5. Socket-welding ends available on request.

FORGED
1000 p.s.i. CWP Service

CAST
150 p.s.i. Steam Service

SIZE	1/8	1/4			3/8	1/2			
A	13/16	13/16			15/16	1 1/8			
B	1 1/16	1 1/16			1 3/16	7/8			
C	1-11/16	1 7/32			1 7/16	1 5/8			
DIA.	49/64	49/64			1 1/64	1 13/64			

CAST
150 p.s.i. Steam Service

SIZE	3/4	1	1 1/4	1 1/2	2	2 1/2	3	4	
A	1 5/16	1 1/2	1 3/4	1 15/16	2 1/4	2 11/16	3 1/16	3 13/16	
B	1	1 1/8	1 5/16	1 7/16	1 11/16	1 15/16	2 3/16	2 5/8	
C	1 7/8	2 1/8	2 1/2	2 3/4	3 1/4	3 7/8	4 1/2	5 11/16	
DIA.	1 15/32	1 13/16	2 3/16	2 15/32	3	3 19/32	4 9/32	5 13/32	

INDEX

Elbows, Tees, Crosses, Street Elbows	
Threaded 150 LB.....	5
Elbows and Tees	
Threaded 2000 LB – 3000 LB – 6000 LB	6
Couplings, Reducers and Caps	
Threaded 150 LB – 3000 LB – 6000 LB.....	7
Unions – Threaded 150 LB – 3000 LB.....	8
Swage Nipple – Locknuts – Weld Spuds	8
Plugs & Bushings.....	9
Class 150 S/W Econ-O-Lite.....	10
Class 3M & 6M S/W SP79 Inserts.....	11
Couplings, Reducers, Half Couplings, Caps	
Socket Weld 3000 LB – 6000 LB	12
Elbows, Tees, Crosses	
Socket Weld 3000 LB – 6000 LB.....	13
ASP Calculated Unit Weights.....	14 & 15
Material Specifications.....	16



ALLOY STAINLESS

Products Company Inc Totowa Borough, N.J.

ELBOWS AND TEES

THREADED FITTINGS

**FORGED
High Pressure Service**

SIZE	1/8	1/4	3/8	1/2	3/4	1	1 1/4	1 1/2	2
2000 p.s.i. COLD NON-SHOCK SERVICE									
A	13/16	13/16	31/32	1 1/8	15/16	1 1/2	1 3/4	2	2 3/8
B	1 1/16	1 1/16	3/4	7/8	1	1 1/8	1 15/16	1 3/8	1 11/16
DIA.	7/8	7/8	1 1/16	1 5/16	1 1/2	1 13/16	2 3/16	2 7/16	2 31/32
3000 p.s.i. COLD NON-SHOCK SERVICE									
A	13/16	31/32	1 1/8	1 5/16	1 1/2	1 3/4	2	2 3/8	2 1/2
B	1 1/16	3/4	7/8	1	1 1/8	1 5/16	1 3/8	1 11/16	1 23/32
DIA.	7/8	1 1/16	1 5/16	1 1/2	1 13/16	2 3/16	2 7/16	2 31/32	3 5/16
6000 p.s.i. COLD NON-SHOCK SERVICE									
A	31/32	1 1/8	1 5/16	1 1/2	1 3/4	2	2 3/8	2 1/2	—
B	3/4	7/8	1	1 1/8	1 5/16	1 3/8	1 11/16	1 23/32	—
DIA.	1 1/16	1 5/16	1 1/2	1 13/16	2 3/16	2 7/16	2 1/32	3 5/16	—

SIZE	2 1/2	3							
2000 p.s.i. COLD NON-SHOCK SERVICE									
A	3	3 3/8							
B	—	—							
DIA.	3 5/8	4 5/16							
3000 p.s.i. COLD NON-SHOCK SERVICE									
A	3 3/8	3 3/4							
B	—	—							
DIA.	4 5/16	4 3/4							

*Specialty and Custom Fittings
Available Subject to Quotation*

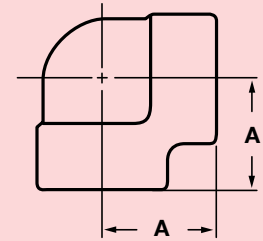

90° ELBOW

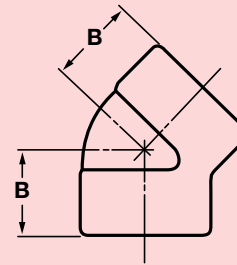

45° ELBOW

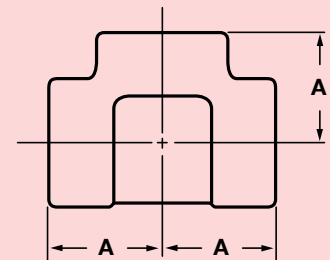

TEE

NOTES:

1. Dimensions of 90s, Tees, 45s, and Crosses conform to ASME B16.11.
2. Cross Dimensions correspond to Center-to-end and Diameter dimensions of Tees.
3. Pipe Threads conform to ASME B1.20.1.
4. Reducing 90 Degree Elbows, Tees, and Crosses are available upon request.
5. Dimensions of 3000 LB Street Elbows are available upon request.



COUPLINGS-REDUCERS-CAPS

THREADED FITTINGS

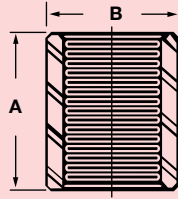

COUPLING

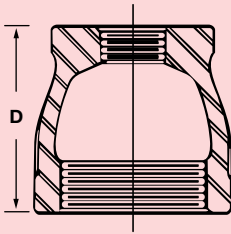

REDUCING COUPLING

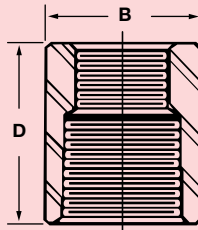

REDUCING COUPLING

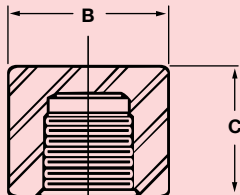

CAP

NOTES:

1. Dimensions of 150 LB items conform to MSS-SP-114. Socket Welding Fittings available upon request.
2. Dimensions of 3000 LB and 6000 LB items conform to ASME B16.11.
3. Pipe Threads conform to ASME B1.20.1
4. 150 LB Half-Couplings are approximately half the length of 150 LB Full Couplings.
5. 2½" thru 4" 150 LB Cast Reducing Couplings are Bell Reducers.
6. 150 LB Forged/Barstock Couplings and Reducers up to 2" and Caps up to 1" are suitable for use at 1000 psi CWP.

SIZE	1/8	1/4	3/8	1/2	3/4	1	1¼	1½	2
1000 p.s.i. COLD NON-SHOCK SERVICE (BAR OR FORGED)									
A	1	1	1½	1¾	1½	1⅝	2	2⅛	2½
B	5/8	¾	7/8	1¼	1⅝	1⅝	1⅞	2¼	2¾
C	¾	7/8	1⅝	1⅝	1¼	1½	1⅝	1¾	1⅞
D	1	1	1½	1¾	1½	1⅝	2	2⅝	2⅞
3000 p.s.i. COLD NON-SHOCK SERVICE (BAR OR FORGED)									
A&D	1¼	1⅝	1½	1⅞	2	2⅝	2⅝	3⅛	3⅝
B	5/8	¾	7/8	1½	1¾	1¾	2¼	2½	3
C	¾	1	1	1¼	1⅞	1⅝	1¾	1⅞	2
6000 p.s.i. COLD NON-SHOCK SERVICE (BAR OR FORGED)									
A&D	1¼	1⅝	1½	1⅞	2	2⅝	2⅝	3⅛	3⅝
B	7/8	1	1¼	1½	1¾	2¼	2½	3	3⅝
C	13/16	1⅞	1¼	1⅞	1⅞	1⅞	1⅞	1⅞	2⅞
150 p.s.i. STEAM SERVICE (CAST)									
SIZE	2½	3	4						
A	3	3¼	3¾						
B	3⅝	4	5⅞						
C	2	2¼	2½						
D	3¼	3⅞	4¾						
3000 p.s.i. COLD NON-SHOCK SERVICE (BAR OR FORGED)									
A&D	3⅝	4¼	4¾						
B	3⅝	4¼	5½						
C	2⅝	2⅞	1⅞						



UNIONS

THREADED FITTINGS

FORGED OR BAR STOCK

SIZE	1/8	1/4	3/8	1/2	3/4	1	1 1/4	1 1/2	2
1000 p.s.i. COLD NON-SHOCK SERVICE									
A	1 1/2	1 1/2	1 1/2	1 13/16	2	2	2 5/8	3	3 1/8
B	1 1/8	1 1/8	1 5/16	1 1/2	1 3/4	2 3/16	2 5/8	3	3 5/8
3000 p.s.i. COLD NON-SHOCK SERVICE									
A	—	1 1/2	1 7/8	2	2	2 1/2	2 7/8	3	3 3/8
B	—	1 5/16	1 1/2	1 3/4	2 3/16	2 1/2	3 1/16	3 13/32	4 5/32
CAST 150 p.s.i. STEAM SERVICE									
SIZE	2 1/2	3	4						
A	3 5/8	4 1/4	4 1/2						
B	4 1/2	5 3/8	6 3/4						

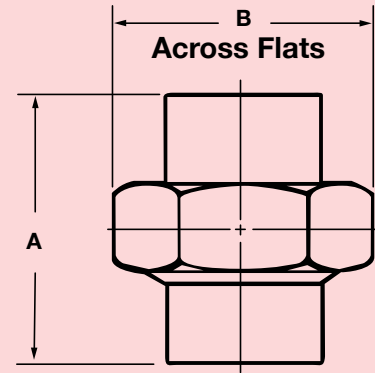

NOTES:

1. Pipe Threads conform to ANSI B1.20.1.
2. 150 LB Unions of any ally are supplied with Type 304 Union Nuts. Type 316 Nuts are available on request.
3. Dimensions of 3000 LB Unions conform to MSS-SP-83.
4. General dimensions of 3000 LB Socket-welding Unions are the same as shown for 3000 LB Threaded Unions of the same size. Dimensions of Socket-Welding End Connections and Fitting Bores conform to MSS-SP-83 and ASME B16.11. requirements for 3000 LB Socket-Welding Fittings.
5. 6000 LB Threaded and Socket-welding Unions are available on request.

NIPPLES, LOCKNUTS AND WELDING SPUDS

THREADED FITTINGS

BAR STOCK OR FORGED (except as noted) 150 p.s.i. Service

SIZE	1/8	1/4	3/8	1/2	3/4	1	1 1/4	1 1/2	2
A	3/4	7/8	1	1 3/16	1 1/2	1 3/4	2 1/8	2 3/8	2 7/8
B	3/8	1/4	9/32	5/16	1 1/32	3/8	7/16	15/32	17/32
C	1 3/8	1 1/2	1 5/8	1 3/4	2	2 1/4	2 11/16	3	3 1/2
D	27/32	31/32	31/32	1 5/32	1 11/32	1 23/32	1 15/16	2 5/16	2 11/16
E	3/32	1/8	1/8	5/32	5/32	3/16	3/16	3/16	3/16
F	15/32	1/2	1/2	19/32	21/32	25/32	3/4	3/4	13/16
G	—	1 1/8	1 1/8	1 1/4	1 1/2	1 5/8	1 3/4	1 3/4	2 1/8

SIZE	2 1/2	3	4						
A	3 1/2	4 9/32	5 3/8						
B	1 9/32	1 1/16	1 3/16						
C	4 1/16	4 5/8	5 13/16						
D	3 3/16	3 11/16	4 3/4						
E	3/16	3/16	3/16						
F	1	1	1 1/8						
G	2 1/4	2 1/4	2 3/8						

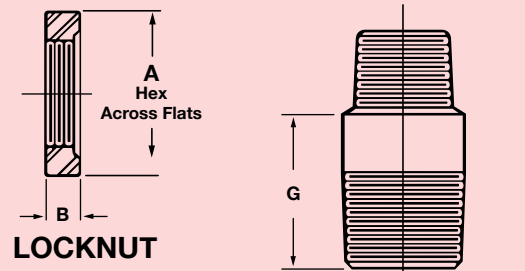

LOCKNUT

REDUCING (SWAGED) NIPPLE

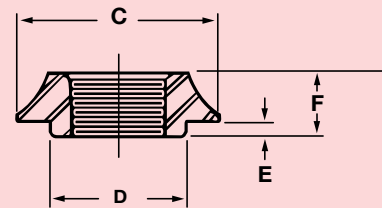

WELDING SPUD

NOTES:

1. Pipe Threads conform to ASME B1.20.1.
2. General dimensions and threading of locknuts are based on ASME B16.14.
3. Locknuts 1-1/2" and larger - CAST.
4. Welding Spuds 2-1/2" and larger - CAST.



PLUGS AND BUSHINGS

THREADED FITTINGS

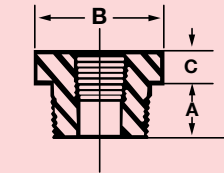

HEX BUSHING

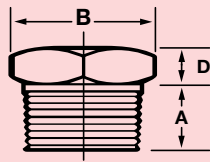

HEX HEAD PLUG

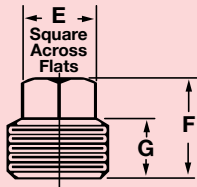

SQUARE HEAD PLUG

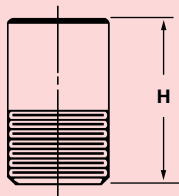

ROUND HEAD PLUG



FLUSH BUSHING

NOTES:

1. Pipe threads conform to ASME B1.20.1.
2. Hex Plugs and Bushings 1/8" through 2", Square Head Plugs 1-1/4" through 2", Flush Bushings and Round Head Plugs conform to ASME B16.11; material conforms to ASTM-A-182.
3. General dimensions of 150 LB Plugs and Bushings are based on ASME B16.14.
4. 150 LB Hex Plugs and Bushings 2-1/2" and 3" Forged; 4" - Cast.
5. 150 LB Square Head Plugs 1" and smaller - Bar or Forged; over 2" - Cast.
6. Non-cast 150 LB items suitable for use at 1000 psi CWP.
7. ASME B16.11 items are not identified by pressure class and may be used for ratings up through ASME Pressure Class 6000.
8. Socket-welding Plugs available on request.

BAR STOCK OR FORGED (except as Noted)

	SIZE	1/8	1/4	3/8	1/2	3/4	1		
	A	3/8	1/2	33/64	43/64	11/16	27/32		
	B	7/16	5/8	3/4	7/8	1 1/8	15/16		
	C	—	1/8	5/32	3/16	7/32	1/4		
	D	1/4	1/4	5/16	5/16	3/8	3/8		
	E	9/32	3/8	7/16	9/16	5/8	13/16		
	F	5/8	1 1/16	13/16	15/16	1 1/16	1 1/4		
	G	3/8	7/16	1/2	9/16	5/8	3/4		
	H	1 3/8	1 5/8	1 5/8	1 3/4	1 3/4	2		
	J	—	7/16	1/2	9/16	5/8	3/4		

	SIZE	1 1/4	1 1/2	2	2 1/2	3	4		
	A	7/8	7/8	15/16	1 1/16	1 1/8	1 1/4		
	B	1 3/4	2	2 1/2	3 3/8	3 5/8	5		
	C	9/32	5/16	11/32	1/2	1/2	5/8		
	D	9/16	5/8	45/64	1/2	1/2	5/8		
	E	15/16	1 1/8	15/16	1 1/2	1 11/16	2 1/2		
	F	1 1/2	1 1/2	1 5/8	2	2 1/8	2 1/2		
	G	13/16	13/16	7/8	1 1/16	1 1/8	1 1/4		
	H	2	2	2 1/2	2 3/4	2 3/4	3		
	J	13/16	13/16	7/8	1 1/16	1 1/8	1 1/4		

*Specialty and Custom Fittings
Available Subject to Quotation*



ALLOY STAINLESS

Products Company Inc Totowa Borough, N.J.

Stainless ECONOLITE

150 LB. SOCKET WELD PIPE FITTINGS

ASP ECONOLITE Socket Weld Pipe Fittings are designed for use where the ruggedness of ASP Pressure Fittings is not required. Installation of socket weld fittings is simple. The sockets support and align the pipe for welding. Ample come-and-go makes accurate measurement and cutting of pipe unnecessary.

SIZE	1/8	1/4	3/8	1/2	3/4	1	1 1/4	1-1/2	2
A	—	—	—	1 1/16	1 1/4	1 7/16	1 11/16	1 7/8	2 3/16
B	—	—	—	3/8	7/16	1/2	1/2	1/2	5/8
C	—	—	—	.855	1.065	1.330	1.675	1.915	2.406
D	—	—	—	7/8	1	1-1/8	1 5/16	1 7/16	1 11/16
E	—	—	—	1 3/8	1 1/2	1 5/8	2	2 1/8	2 1/2
F	—	—	—	1/2	5/8	1 1/16	1 1/16	1 1/16	7/8

- ASP ECONOLITE Socket Weld UNIONS, though not shown on this chart, are available. General over-all dimensions shown on page 8.
- Fittings beyond size range shown here also available.

ASP ECONOLITE FITTINGS BORED FOR SCHEDULE 10 PIPE

Pressure - Temperature

Ratings:

150 P.S.I. saturated steam — 300 P.S.I. @ 150 deg F



ALLOY STAINLESS

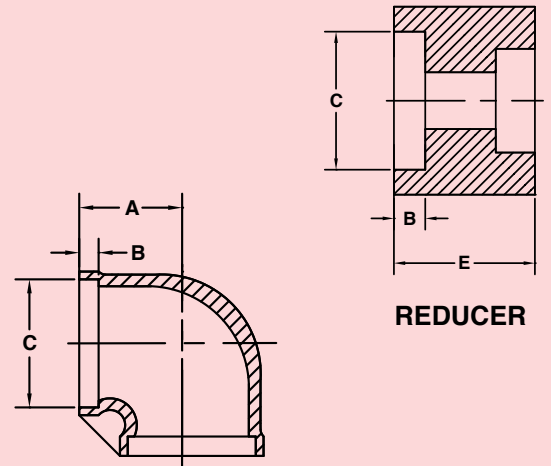

REDUCER

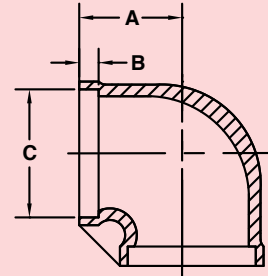

90° ELBOW

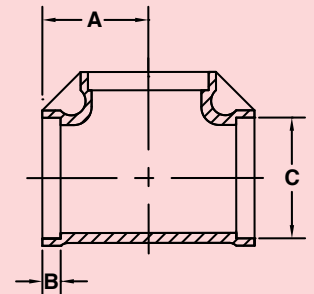

TEE

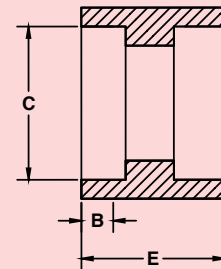

COUPLING

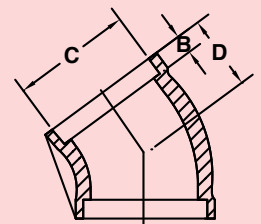

45° ELBOW

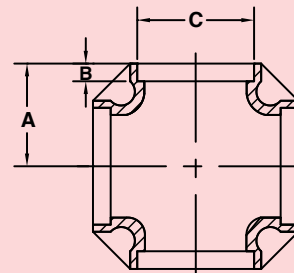

CROSS

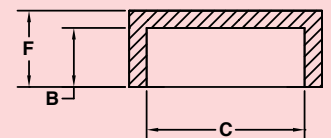

CAP

S/W INSERTS

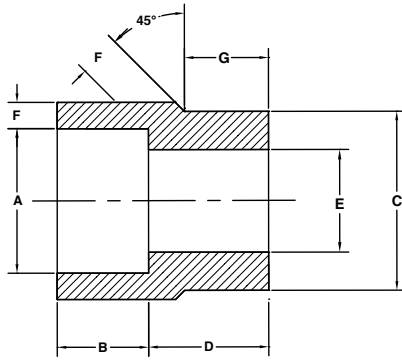

Type 1

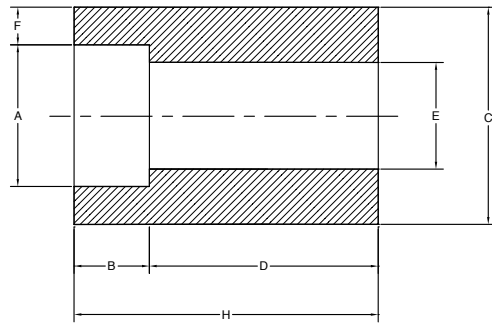

Type 2

Note: All dimensions are in accordance with MSS-SP-79

NPS Common Reductions Other Sizes available upon request	TYPE		A	B	C	D		E		F		G		H	
			Socket		Shank Dia.	Laying Length		Bore		Wall		Length			
	3M	6M	Dia.	Depth		3M	6M	3M	6M	3M	6M	Type 1		Type 2	
												3M	6M	3M	6M
3/8 x 1/4	1	1	.565	.38	.675	.75	.84	.36	.25	.149	.181	.56	.62		
1/2 x 1/4	1	1	.565	.38	.840	.81	.81	.36	.25	.149	.181	.62	.62		
1/2 x 3/8	1	1	.700	.38	.840	.81	.91	.49	.36	.158	.198	.62	.62		
3/4 x 3/8	2	1	.700	.38	1.050	.62	.88	.49	.36	.158	.198		.75	1.06	
3/4 x 1/2	1	1	.865	.38	1.050	.88	1.00	.62	.46	.184	.235	.69	.75		
1 x 1/2	2	1	.865	.38	1.315	.62	1.12	.62	.46	.184	.235		.81	1.12	
1 x 3/4	1	1	1.075	.50	1.315	.94	1.12	.82	.61	.193	.274	.75	.81		
1-1/4 x 1/2	2	2	.865	.38	1.660	.75	.88	.62	.46	.184	.235			1.25	1.37
1-1/4 x 3/4	2	2	1.075	.50	1.660	.69	.81	.82	.61	.193	.274			1.25	1.37
1-1/4 x 1	1	1	1.340	.50	1.660	1.00	1.19	1.05	.81	.224	.312	.81	.88		
1-1/2 x 1/2	2	2	.865	.38	1.900	.81	1.06	.62	.46	.184	.235			1.31	1.56
1-1/2 x 3/4	2	2	1.075	.50	1.900	.75	1.00	.82	.61	.193	.274			1.31	1.56
1-1/2 x 1	2	1	1.340	.50	1.900	.69	1.15	1.05	.81	.224	.312		1.00	1.31	
1-1/2 x 1-1/4	1	1	1.685	.50	1.900	1.12	1.38	1.38	1.16	.239	.312	.88	1.00		
2 x 1/2	2	2	.865	.38	2.375	1.00	1.12	.62	.46	.184	.235			1.50	1.62
2 x 3/4	2	2	1.075	.50	2.375	.94	1.06	.82	.61	.193	.274			1.50	1.62
2 x 1	2	2	1.340	.50	2.375	.88	1.00	1.05	.82	.224	.312			1.50	1.62
2 x 1-1/4	2	2	1.685	.50	2.375	.81	.94	1.38	1.16	.239	.312			1.50	1.62
2 x 1-1/2	1	1	1.925	.50	2.375	1.25	1.53	1.61	1.34	.250	.351	1.00	1.13		
2-1/2 x 1	2		1.340	.50	2.875	1.50		1.05		.224				2.12	
2-1/2 x 1-1/2	2		1.925	.50	2.875	1.38		1.61		.250				2.12	
2-1/2 x 2	1	1	2.416	.62	2.875	1.81	1.68	2.07	1.69	2.730	.430	1.50	1.25		
3 x 1	2		1.340	.50	3.500	1.25		1.05		.224				1.87	
3 x 1-1/2	2		1.925	.50	3.500	1.12		1.61		.250				1.87	
3 x 2	2		2.416	.62	3.500	1.00		2.07		.273				1.87	
3 x 2-1/2	1		2.916	.62	3.500	1.50		2.47		.345		1.25			
4 x 2	2		2.416	.62	4.500	1.50		2.07		.273				2.38	
4 x 3	2		3.545	.62	4.500	1.31		3.07		.375				2.38	

**For Special Dimensions & Adapter Combinations with NPT Threads
Contact ASP Sales with your Requirements**



COUPLINGS AND CAPS

SOCKET WELD FITTINGS

FORGED

SIZE	1/8	1/4	3/8	1/2	3/4	1	1 1/4	1 1/2	2
3000 p.s.i. COLD NON-SHOCK SERVICE									
A	1	1	1 1/16	1 1/4	1 7/16	1 5/8	1 11/16	1 3/4	2 1/4
B	3/4	7/8	1 1/8	1 1/4	1 1/2	1 7/8	2 1/4	2 1/2	3
C	.420	.555	.690	.855	1.065	1.330	1.675	1.915	2.406
D	3/8	3/8	3/8	3/8	1/2	1/2	1/2	1/2	5/8
E	5/8	5/8	5/8	1 1/16	1 3/16	1 5/16	1 5/16	1	1 3/16
6000 p.s.i. COLD NON-SHOCK SERVICE									
A	1	1	1 1/16	1 1/4	1 7/16	1 5/8	1 11/16	1 3/4	2 1/4
B	7/8	1 1/16	1 1/4	1 1/2	1 3/4	2 1/4	2 1/2	3	3 5/8
C	.420	.555	.690	.855	1.065	1.330	1.675	1.915	2.406
D	3/8	3/8	3/8	3/8	1/2	1/2	1/2	1/2	5/8
E	1 1/16	1 1/16	1 1/16	3/4	7/8	1	1	1 1/16	1 5/16

SIZE	2 1/2	3	4						
3000 p.s.i. COLD NON-SHOCK SERVICE									
A	2 5/16	2 3/8	2 5/8						
B	3 5/8	4 3/8	5 1/2						
C	2.906	3.535	4.545						
D	5/8	5/8	3/4						
E	1 5/16	1 7/16	1 11/16						

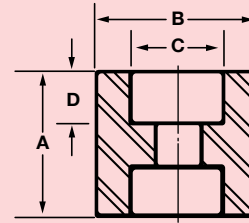

COUPLING

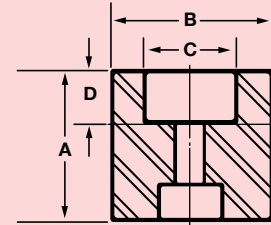

REDUCING COUPLING

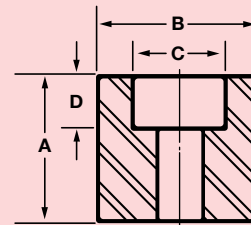

HALF COUPLING

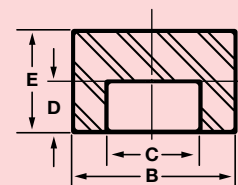

CAP

NOTES:

1. Dimensions conform with ASME B16.11.
2. Bored for use with Schedule 40 Pipe – 3000 p.s.i.
3. Bored for use with Schedule 80 Pipe – 3000 p.s.i.
4. Bored for use with Schedule 160 Pipe – 6000 p.s.i.
5. 9000 LB Fittings available upon request.

REDUCER INSERTS

SOCKET WELD FITTINGS

Produced in 3000 and 6000 classes in Type 1 and Type 2 configurations from 3/4" through 4" sizes. Dimensions (not shown in this catalog) conform to MSS Standard Practice SP-79. Copies of dimensional tables for ASP Socket Welding Reducer Inserts are promptly available upon request.



ELBOWS-TEES-CROSSES

SOCKET WELD FITTINGS

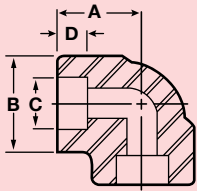

90° ELBOW

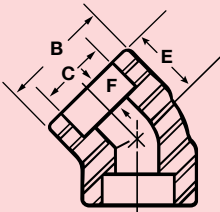
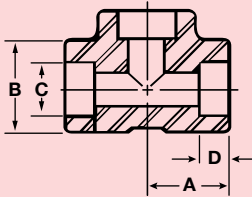

45° ELBOW

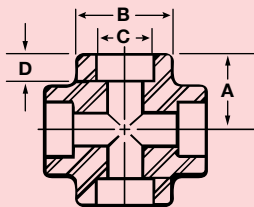

CROSS

NOTES:

1. Dimensions conform with ASME B16.11.
2. Bored for use with Schedule 40 Pipe – 3000 p.s.i.
3. Bored for use with Schedule 80 Pipe – 3000 p.s.i.
4. Bored for use with Schedule 160 Pipe – 6000 p.s.i.
5. Reducing Fittings available upon request.
6. 9000 LB Fittings available upon request.

FORGED

SIZE	1/8	1/4	3/8	1/2	3/4	1	1 1/4	1 1/2	2
3000 p.s.i. COLD NON-SHOCK SERVICE									
A	13/16	13/16	31/32	1 1/8	1 15/16	1 1/2	1 3/4	2	2 3/8
B	7/8	7/8	1 1/16	1 5/16	1 1/2	1 13/16	2 3/16	2 7/16	2 31/32
C	.420	.555	.690	.855	1.065	1.330	1.675	1.915	2.406
D	3/8	3/8	7/16	1/2	9/16	5/8	1 1/16	3/4	7/8
E	1 1/16	1 1/16	3/4	7/8	1	1 1/8	1 5/16	1 3/8	1 11/16
F	3/8	3/8	7/16	7/16	1/2	9/16	5/8	17/32	1 1/16
6000 p.s.i. COLD NON-SHOCK SERVICE									
A			1 1/8	1 5/16	1 1/2	1 3/4	2	2 3/8	2 1/2
B			1 5/16	1 1/2	1 13/16	2 3/16	2 7/16	2 21/32	3 5/16
C			.690	.855	1.065	1.330	1.675	1.915	2.406
D			1 9/32	1 1/16	3/4	7/8	1 5/16	1 1/8	1
E			7/8	1	1 1/8	1 5/16	1 3/8	1 11/16	1 23/32
F			1/2	5/8	1 1/16	13/16	23/32	13/32	27/32

SIZE	2 1/2	3							
3000 p.s.i. COLD NON-SOCK SERVICE									
A	3	3 3/8							
B	3 5/8	4 5/16							
C	2.906	3.535							
D	5/8	5/8							

SPECIALTY HIGH ALLOYS
F321 - AL6XN - MONEL 400 -
317/317L - DUPLEX -
HASTEALLOY C-276
In Stock!



ASP UNIT WEIGHTS

CALCULATED IN LBS.

SIZE		1/8"	1/4"	3/8"	1/2"	3/4"	1"	1 1/4"	1 1/2"	2"	2 1/2"	3"	4"	
150 LB. THREADED	90° Elbow	.14	.11	.19	.36	.56	.93	1.06	1.73	2.35	4.38	6.38	10.30	
	Tee	.20	.14	.26	.53	.74	1.23	2.03	2.18	3.48	5.91	9.37	16.01	
	45° Elbow	.12	.09	.12	.31	.56	.77	1.12	1.56	2.06	3.80	5.87	9.54	
	Cross	.37	.31	.49	.85	1.19	1.49	2.03	2.97	4.31	7.55	9.81	17.80	
	St. Elbow	.09	.14	.20	.32	.50	.86	1.28	1.58	2.39	5.76	7.86	15.23	
	Coupling	.05	.08	.10	.17	.26	.41	.50	.86	1.33	2.29	3.31	5.37	
	Red'r Cplg.	+	+	+	+	+	+	+	+	+	+	+	+	+
	Half Cplg.	.03	.04	.05	.09	.14	.22	.26	.44	.68	1.16	1.69	2.70	
	Cap	.05	.08	.10	.15	.28	.50	.69	.91	1.29	2.36	3.67	5.59	
	Union	.24	.21	.28	.41	.62	.82	1.58	2.07	3.00	6.82	11.04	17.00	
	Lock Nut	.03	.03	.08	.06	.11	.14	.22	.28	.46	.80	.91	2.22	
Weld Spud	.12	.14	.17	.17	.22	.36	.35	.60	.66	1.20	1.36	2.61		

+ All Red'r Cplg. weights average 20% to 40% more than straight couplings.

150 LB.	Hex Bushing	—	—	—	—	—	—	—	—	—	1.50	2.08	4.59
	Sq. Hd. Plug	—	—	—	—	—	—	—	—	—	1.82	2.56	6.56
	Hex. Hd. Plug	—	—	—	—	—	—	—	—	—	2.58	3.61	7.20

Hex bushing weights based on single reduction.

2000 LB. THREADED	90° Elbow	.23	.18	.31	.55	.69	1.00	1.76	2.19	3.73	7.60	11.93	—
	Tee	.28	.26	.42	.70	.95	1.40	2.14	3.00	4.33	9.31	13.32	—
	45° Elbow	.34	.30	.35	.48	.60	.92	1.40	1.73	2.89	—	—	—
	Cross	.37	.31	.49	.85	1.19	1.60	2.10	3.35	4.75	—	—	—

3000 LB. THREADED	90° Elbow	.23	.39	.64	.93	1.52	2.44	3.06	5.68	5.61	11.03	18.83	—	
	Tee	.28	.50	.84	1.24	1.90	3.23	3.66	6.93	7.37	14.61	22.82	—	
	45° Elbow	.34	.25	.50	.78	.86	2.06	2.18	4.41	4.51	—	—	—	
	Cross	.37	.60	.90	1.54	2.41	3.71	4.98	8.68	—	—	—	—	
	St. Elbow	.09	.22	.35	.52	.81	1.38	—	—	—	—	—	—	
	Coupling	.08	.11	.13	.29	.43	.85	1.58	2.16	2.97	4.86	6.67	12.37	
	Red'r Cplg.	+	+	+	+	+	+	+	+	+	+	+	+	+
	Half Cplg.	.05	.06	.08	.15	.22	.43	.78	1.09	1.50	2.50	3.41	6.25	
	Cap	.06	.10	.11	.24	.41	.77	1.29	1.71	2.48	4.70	6.35	15.19	
Union	.36	.32	.49	.79	1.06	1.72	2.60	3.33	5.20	8.36	11.78	—		

+ All Red'r Cplg. weights average 20% to 40% more than straight couplings.



ASP UNIT WEIGHTS

CALCULATED IN LBS.

SIZE	1/8"	1/4"	3/8"	1/2"	3/4"	1"	1 1/4"	1 1/2"	2"	2 1/2"	3"	4"
------	------	------	------	------	------	----	--------	--------	----	--------	----	----

6000 LB. THREADED	90° Elbow	.35	.68	.95	1.72	2.76	3.79	6.66	8.39	13.74	23.24	—	—
	Tee	.44	.91	1.36	2.21	3.57	5.11	8.25	10.46	17.54	30.56	—	—
	45° Elbow	.28	.57	.86	1.41	2.25	2.81	5.28	6.16	—	—	—	—
	Coupling	.18	.23	.40	.69	.95	1.90	2.27	4.11	6.17	9.25	13.65	—
	Red'r Cplg.	+	+	+	+	+	+	+	+	+	+	+	—
	Half Cplg.	.10	.12	.21	.35	.49	.98	1.15	2.08	3.15	4.65	6.85	—
	Cap	.13	.19	.34	.55	.78	1.62	1.91	3.07	4.53	7.37	11.32	—

+ All Red'r Cplg. weights average 20% to 40% more than straight couplings.

ANSI B 16.11 150-3000 6000	Hex Bushing	—	.03	.05	.08	.15	.21	.32	.33	.73	—	—	—
	Sq. Hd. Plug	.02	.03	.07	.12	.20	.33	.68	.88	1.44	—	—	—
	Hex. Hd. Plug	.04	.06	.11	.17	.30	.48	.86	1.28	2.11	—	—	—

Hex bushing weights based on single reduction.

3000 LB. SOCKET WELD	90° Elbow	.20	.16	.31	.50	.69	1.16	1.69	2.42	3.66	7.34	11.61	—
	Tee	.28	.23	.39	.68	.91	1.44	2.19	2.74	4.43	8.49	13.85	—
	45° Elbow	.19	.17	.27	.44	.61	.88	1.43	1.59	2.91	—	—	—
	Cross	.27	.28	.47	.74	1.16	1.57	2.53	3.59	5.50	—	—	—
	Coupling	.09	.11	.18	.28	.39	.76	1.01	1.28	2.05	3.12	3.83	7.13
	Red'r Cplg.	+	+	+	+	+	+	+	+	+	+	+	+
	Half Cplg.	.11	.13	.21	.33	.48	.86	1.18	1.45	2.37	3.45	4.21	7.84
	Cap	.05	.09	.13	.23	.36	.61	.96	1.19	1.89	2.79	4.43	7.86
Union	.36	.32	.49	.79	1.08	1.73	2.56	3.34	5.12	8.36	11.78	—	

+ All Red'r Cplg. weights average 20% to 40% more than straight couplings.

6000 LB. SOCKET WELD	90° Elbow	.37	.32	.60	.96	1.67	2.54	3.18	6.13	7.27	12.06	21.16	—
	Tee	.44	.41	.81	1.18	2.03	3.39	4.22	7.66	8.60	15.09	25.24	—
	45° Elbow	.25	.24	.48	.76	1.21	2.20	2.34	4.69	4.91	—	—	—
	Coupling	.18	.16	.29	.49	.71	1.39	1.63	2.74	4.60	6.36	8.86	—
	Red'r Cplg.	+	+	+	+	+	+	+	+	+	+	+	—
	Half Cplg.	.20	.18	.32	.54	.78	1.53	1.79	3.01	5.06	6.99	9.75	—
	Cap	.13	.17	.27	.43	.58	1.18	1.41	2.50	3.83	5.24	7.71	—

+ All Red'r Cplg. weights average 20% to 40% more than straight couplings.



ASP

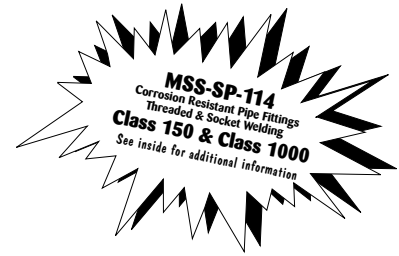

MATERIAL SPECIFICATIONS

ASTM SPEC	ALLOY	CHEMICAL COMPOSITION								MECHANICAL PROPERTIES							
		C MAX	M MAX	P MAX	S MAX	SI MAX	NI M/M	CR M/M	MO M/M	TS KSI MIN	YP KSI MIN	ELON 2" MIN	RED/AREA MIN				
ASP STAINLESS STEEL FITTINGS MACHINED FROM FORGINGS & WROUGHT BAR																	
A-182	304	0.08	2.00	0.040	0.030	1.00	8.00	18.00	2.00	75	30	30%	50%				
	304H	0.04 0.10					To 11.00							To 20.00			
	304L	0.035					8.00 13.00							To 3.00	70	25	30%
	316	0.08					10.00 14.00							To 18.00	75	30	30%
	316L	0.035					10.00 15.00							To 3.00	70	25	30%
ASP STAINLESS STEEL FITTINGS MACHINED FROM CASTINGS																	
A-351	CF-8 (340)	0.08	1.50	0.040	0.040	2.00	8.00	18.00	2.00	70	30	35%					
	CF-3 (304L)	0.03					8.00	17.00						To 3.00	70	30	35%
	CF-8M (316)	0.08					9.00	18.00						To 3.00	70	30	30%
	CF-3M (316L)	0.03					9.00	17.00						To 3.00	70	30	30%
	CN-7M (A-20)	.07					27.50	19.00						To 3.00	62	25	35%
ASP ALLOY-20 FITTINGS MACHINED FROM FORGINGS & WROUGHT BAR																	
B-462 B-473	UNS N08020	0.07	2.00	0.045	0.035	1.00	32.00 38.00	19.00 21.00	2.00 3.00	80	35	30%	50%				

CU 3.0 to 4.0
Columbium + Tantalum - 8 x C. Min. to 1.0 Max.
*Cold finished shapes require only 15% Min. Elon.

ALLOY STAINLESS PRODUCTS COMPANY INC.

Time Proven Fittings Since 1944



MANUFACTURERS OF STAINLESS STEEL PIPE FITTINGS
611 UNION BOULEVARD, TOTOWA, NEW JERSEY 07512
Tel: 973-256-1616 FAX: 973-256-5256
www.alloystainless.com